

ECEN 615

Methods of Electric Power Systems Analysis

Lecture 4: Power Flow

Prof. Tom Overbye

Dept. of Electrical and Computer Engineering

Texas A&M University

overbye@tamu.edu



TEXAS A&M
UNIVERSITY

Announcements



- RSVP to Alex at zandra23@ece.tamu.edu for the TAMU ECE Energy and Power Group (EPG) picnic. It starts at 5pm on September 27, 2019
- Read Chapter 6 from the book
 - They formulate the power flow using the polar form for the Y_{bus} elements
- Homework 1 is due on Thursday September 12

Two Bus Newton-Raphson Example



- For the two bus power system shown below, use the Newton-Raphson power flow to determine the voltage magnitude and angle at bus two. Assume that bus one is the slack and $S_{\text{Base}} = 100 \text{ MVA}$.

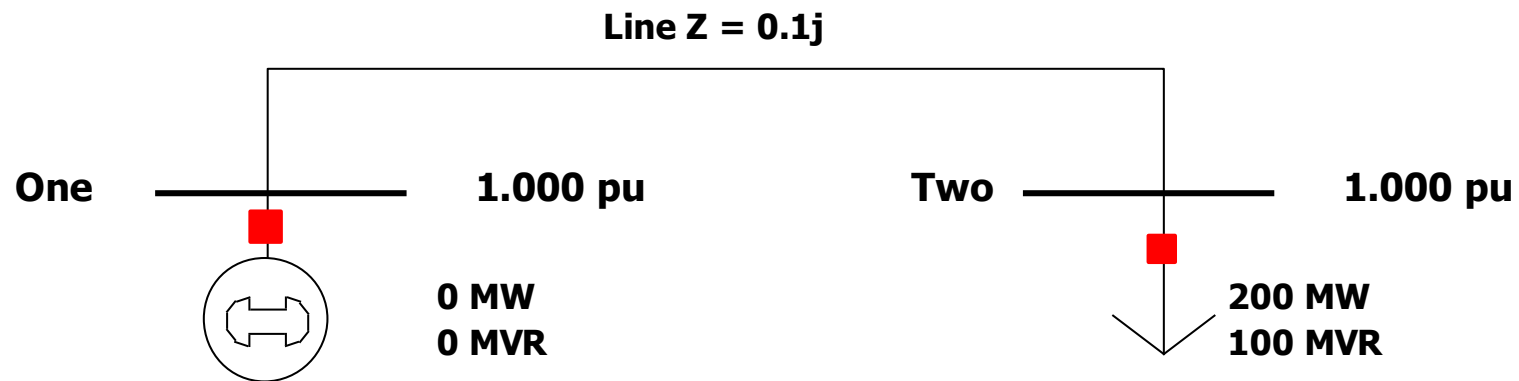

$$\mathbf{x} = \begin{bmatrix} \theta_2 \\ |V_2| \end{bmatrix} \quad \mathbf{Y}_{bus} = \begin{bmatrix} -j10 & j10 \\ j10 & -j10 \end{bmatrix}$$

Two Bus Example, cont'd



General power balance equations

$$P_i = \sum_{k=1}^n |V_i||V_k|(G_{ik} \cos \theta_{ik} + B_{ik} \sin \theta_{ik}) = P_{Gi} - P_{Di}$$

$$Q_i = \sum_{k=1}^n |V_i||V_k|(G_{ik} \sin \theta_{ik} - B_{ik} \cos \theta_{ik}) = Q_{Gi} - Q_{Di}$$

Bus two power balance equations

$$|V_2||V_1|(10 \sin \theta_2) + 2.0 = 0$$

$$|V_2||V_1|(-10 \cos \theta_2) + |V_2|^2 (10) + 1.0 = 0$$

Two Bus Example, cont'd



$$P_2(\mathbf{x}) = |V_2|(10\sin\theta_2) + 2.0 = 0$$

$$Q_2(\mathbf{x}) = |V_2|(-10\cos\theta_2) + |V_2|^2(10) + 1.0 = 0$$

Now calculate the power flow Jacobian

$$J(\mathbf{x}) = \begin{bmatrix} \frac{\partial P_2(\mathbf{x})}{\partial \theta_2} & \frac{\partial P_2(\mathbf{x})}{\partial |V|_2} \\ \frac{\partial Q_2(\mathbf{x})}{\partial \theta_2} & \frac{\partial Q_2(\mathbf{x})}{\partial |V|_2} \end{bmatrix}$$
$$= \begin{bmatrix} 10|V_2|\cos\theta_2 & 10\sin\theta_2 \\ 10|V_2|\sin\theta_2 & -10\cos\theta_2 + 20|V_2| \end{bmatrix}$$

Two Bus Example, First Iteration



$$\text{Set } v = 0, \text{ guess } \mathbf{x}^{(0)} = \begin{bmatrix} 0 \\ 1 \end{bmatrix}$$

Calculate

$$\mathbf{f}(\mathbf{x}^{(0)}) = \begin{bmatrix} |V_2|(10\sin\theta_2) + 2.0 \\ |V_2|(-10\cos\theta_2) + |V_2|^2(10) + 1.0 \end{bmatrix} = \begin{bmatrix} 2.0 \\ 1.0 \end{bmatrix}$$

$$\mathbf{J}(\mathbf{x}^{(0)}) = \begin{bmatrix} 10|V_2|\cos\theta_2 & 10\sin\theta_2 \\ 10|V_2|\sin\theta_2 & -10\cos\theta_2 + 20|V_2| \end{bmatrix} = \begin{bmatrix} 10 & 0 \\ 0 & 10 \end{bmatrix}$$

$$\text{Solve } \mathbf{x}^{(1)} = \begin{bmatrix} 0 \\ 1 \end{bmatrix} - \begin{bmatrix} 10 & 0 \\ 0 & 10 \end{bmatrix}^{-1} \begin{bmatrix} 2.0 \\ 1.0 \end{bmatrix} = \begin{bmatrix} -0.2 \\ 0.9 \end{bmatrix}$$

Two Bus Example, Next Iterations



$$\mathbf{f}(\mathbf{x}^{(1)}) = \begin{bmatrix} 0.9(10\sin(-0.2)) + 2.0 \\ 0.9(-10\cos(-0.2)) + 0.9^2 \times 10 + 1.0 \end{bmatrix} = \begin{bmatrix} 0.212 \\ 0.279 \end{bmatrix}$$

$$\mathbf{J}(\mathbf{x}^{(1)}) = \begin{bmatrix} 8.82 & -1.986 \\ -1.788 & 8.199 \end{bmatrix}$$

$$\mathbf{x}^{(2)} = \begin{bmatrix} -0.2 \\ 0.9 \end{bmatrix} - \begin{bmatrix} 8.82 & -1.986 \\ -1.788 & 8.199 \end{bmatrix}^{-1} \begin{bmatrix} 0.212 \\ 0.279 \end{bmatrix} = \begin{bmatrix} -0.233 \\ 0.8586 \end{bmatrix}$$

$$\mathbf{f}(\mathbf{x}^{(2)}) = \begin{bmatrix} 0.0145 \\ 0.0190 \end{bmatrix} \quad \mathbf{x}^{(3)} = \begin{bmatrix} -0.236 \\ 0.8554 \end{bmatrix}$$

$$\mathbf{f}(\mathbf{x}^{(3)}) = \begin{bmatrix} 0.0000906 \\ 0.0001175 \end{bmatrix} \quad \text{Done!} \quad V_2 = 0.8554 \angle -13.52^\circ$$

Two Bus Solved Values



- Once the voltage angle and magnitude at bus 2 are known we can calculate all the other system values, such as the line flows and the generator reactive power

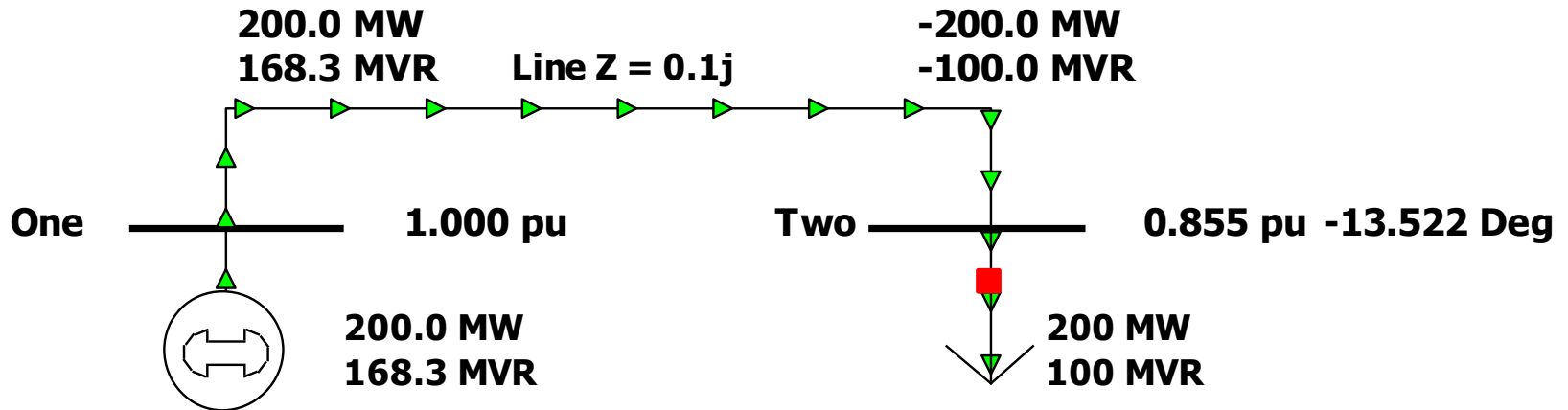

PowerWorld Case Name: **Bus2_Intro**

Note, most PowerWorld cases will be available on the course website

Two Bus Case Low Voltage Solution



This case actually has two solutions! The second "low voltage" is found by using a low initial guess.

$$\text{Set } v = 0, \text{ guess } \mathbf{x}^{(0)} = \begin{bmatrix} 0 \\ 0.25 \end{bmatrix}$$

Calculate

$$\mathbf{f}(\mathbf{x}^{(0)}) = \begin{bmatrix} |V_2|(10\sin\theta_2) + 2.0 \\ |V_2|(-10\cos\theta_2) + |V_2|^2(10) + 1.0 \end{bmatrix} = \begin{bmatrix} 2 \\ -0.875 \end{bmatrix}$$

$$\mathbf{J}(\mathbf{x}^{(0)}) = \begin{bmatrix} 10|V_2|\cos\theta_2 & 10\sin\theta_2 \\ 10|V_2|\sin\theta_2 & -10\cos\theta_2 + 20|V_2| \end{bmatrix} = \begin{bmatrix} 2.5 & 0 \\ 0 & -5 \end{bmatrix}$$

Low Voltage Solution, cont'd



$$\text{Solve } \mathbf{x}^{(1)} = \begin{bmatrix} 0 \\ 0.25 \end{bmatrix} - \begin{bmatrix} 2.5 & 0 \\ 0 & -5 \end{bmatrix}^{-1} \begin{bmatrix} 2 \\ -0.875 \end{bmatrix} = \begin{bmatrix} -0.8 \\ 0.075 \end{bmatrix}$$
$$\mathbf{f}(\mathbf{x}^{(2)}) = \begin{bmatrix} 1.462 \\ 0.534 \end{bmatrix} \quad \mathbf{x}^{(2)} = \begin{bmatrix} -1.42 \\ 0.2336 \end{bmatrix} \quad \mathbf{x}^{(3)} = \begin{bmatrix} -0.921 \\ 0.220 \end{bmatrix}$$

Practical Power Flow Software Note



- Most commercial software packages have built in defaults to prevent convergence to low voltage solutions.
 - One approach is to automatically change the load model from constant power to constant current or constant impedance when the load bus voltage gets too low
 - In PowerWorld these defaults can be modified on the Tools, Simulator Options, Advanced Options page; note you also need to disable the “Initialize from Flat Start Values” option
 - The PowerWorld case Bus2_Intro_Low is set solved to the low voltage solution
 - Initial bus voltages can be set using the Bus Information Dialog

Two Bus Region of Convergence



Slide shows the region of convergence for different initial guesses of bus 2 angle (x-axis) and magnitude (y-axis)

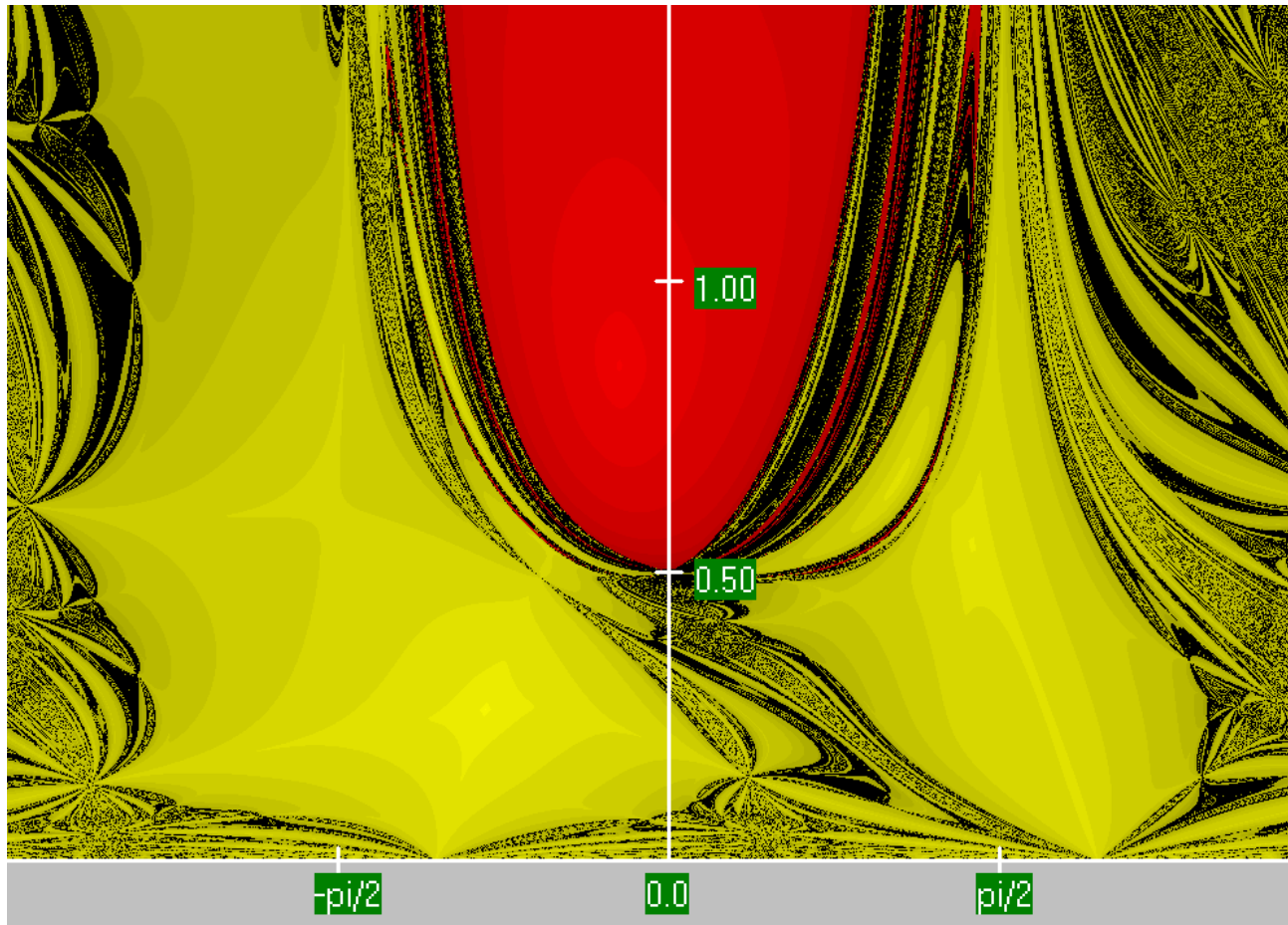

Red region converges to the high voltage solution, while the yellow region converges to the low voltage solution

Power Flow Fractal Region of Convergence



- Earliest paper showing fractal power flow regions of convergence is by C.L DeMarco and T.J. Overbye, “Low Voltage Power Flow Solutions and Their Role in Exit Time Bases Security Measures for Voltage Collapse,” *Proc. 27th IEEE CDC*, December 1988
- A more widely known paper is J.S. Thorp, S.A. Naqavi, “Load-Flow Fractals Draw Clues to Erratic Behavior,” *IEEE Computer Applications in Power*, January 1997

PV Buses



- Since the voltage magnitude at PV buses is fixed there is no need to explicitly include these voltages in \mathbf{x} or write the reactive power balance equations
 - the reactive power output of the generator varies to maintain the fixed terminal voltage (within limits)
 - optionally these variations/equations can be included by just writing the explicit voltage constraint for the generator bus

$$|V_i| - V_{i \text{ setpoint}} = 0$$

Three Bus PV Case Example



For this three bus case we have

$$\mathbf{x} = \begin{bmatrix} \theta_2 \\ \theta_3 \\ |V_2| \end{bmatrix} \quad \mathbf{f}(\mathbf{x}) = \begin{bmatrix} P_2(\mathbf{x}) - P_{G2} + P_{D2} \\ P_3(\mathbf{x}) - P_{G3} + P_{D3} \\ Q_2(\mathbf{x}) + Q_{D2} \end{bmatrix} = 0$$

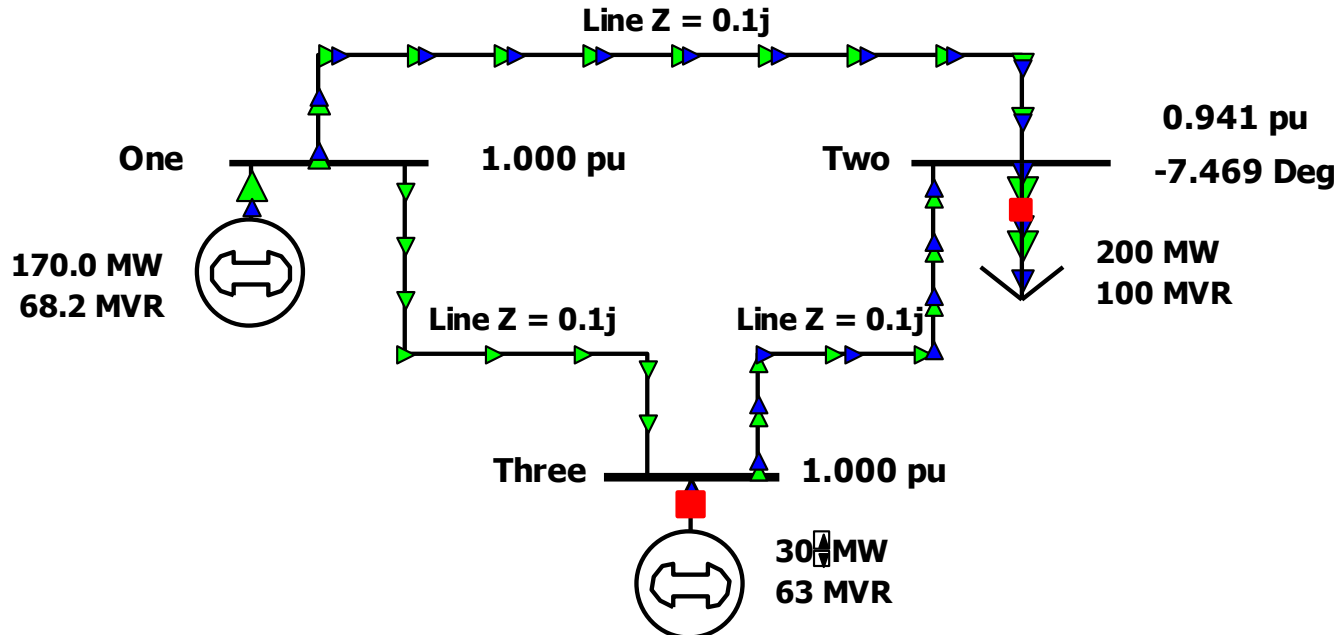

Modeling Voltage Dependent Load



So far we've assumed that the load is independent of the bus voltage (i.e., constant power). However, the power flow can be easily extended to include voltage dependence with both the real and reactive load. This is done by making P_{Di} and Q_{Di} a function of $|V_i|$:

$$\sum_{k=1}^n |V_i| |V_k| (G_{ik} \cos \theta_{ik} + B_{ik} \sin \theta_{ik}) - P_{Gi} + P_{Di}(|V_i|) = 0$$

$$\sum_{k=1}^n |V_i| |V_k| (G_{ik} \sin \theta_{ik} - B_{ik} \cos \theta_{ik}) - Q_{Gi} + Q_{Di}(|V_i|) = 0$$

Voltage Dependent Load Example



In previous two bus example now assume the load is constant impedance, so

$$P_2(\mathbf{x}) = |V_2|(10\sin\theta_2) + 2.0|V_2|^2 = 0$$

$$Q_2(\mathbf{x}) = |V_2|(-10\cos\theta_2) + |V_2|^2(10) + 1.0|V_2|^2 = 0$$

Now calculate the power flow Jacobian

$$J(\mathbf{x}) = \begin{bmatrix} 10|V_2|\cos\theta_2 & 10\sin\theta_2 + 4.0|V_2| \\ 10|V_2|\sin\theta_2 & -10\cos\theta_2 + 20|V_2| + 2.0|V_2| \end{bmatrix}$$

Voltage Dependent Load, cont'd



Again set $v = 0$, guess $\mathbf{x}^{(0)} = \begin{bmatrix} 0 \\ 1 \end{bmatrix}$

Calculate

$$\mathbf{f}(\mathbf{x}^{(0)}) = \begin{bmatrix} |V_2|(10 \sin \theta_2) + 2.0|V_2|^2 \\ |V_2|(-10 \cos \theta_2) + |V_2|^2(10) + 1.0|V_2|^2 \end{bmatrix} = \begin{bmatrix} 2.0 \\ 1.0 \end{bmatrix}$$

$$\mathbf{J}(\mathbf{x}^{(0)}) = \begin{bmatrix} 10 & 4 \\ 0 & 12 \end{bmatrix}$$

$$\text{Solve } \mathbf{x}^{(1)} = \begin{bmatrix} 0 \\ 1 \end{bmatrix} - \begin{bmatrix} 10 & 4 \\ 0 & 12 \end{bmatrix}^{-1} \begin{bmatrix} 2.0 \\ 1.0 \end{bmatrix} = \begin{bmatrix} -0.1667 \\ 0.9167 \end{bmatrix}$$

Voltage Dependent Load, cont'd



With constant impedance load the MW/Mvar load at bus 2 varies with the square of the bus 2 voltage magnitude. This if the voltage level is less than 1.0, the load is lower than 200/100 MW/Mvar

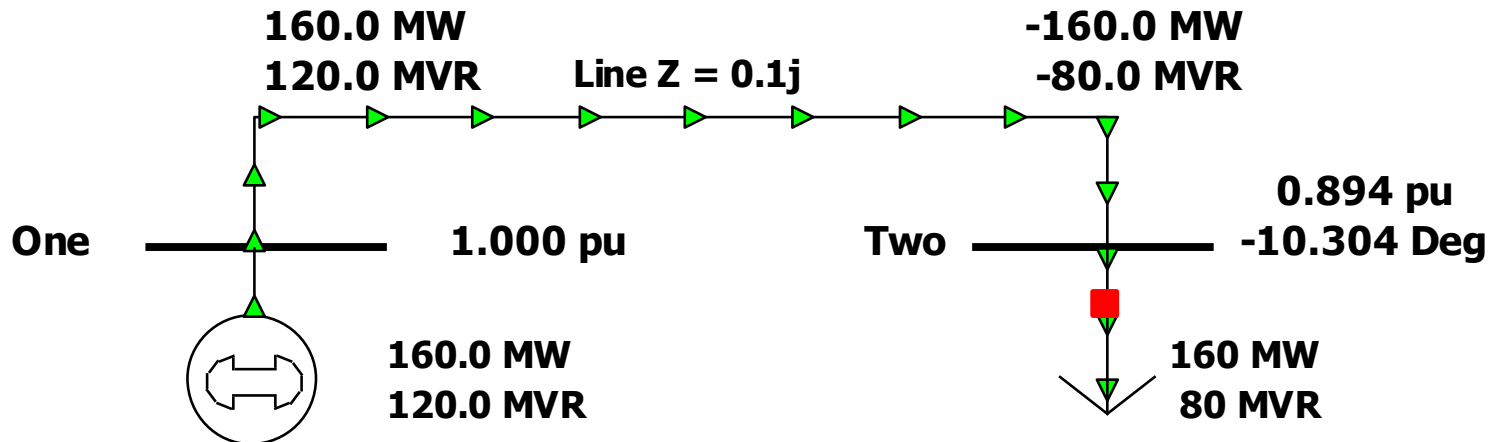

PowerWorld Case Name: **Bus2_Intro_Z**

Generator Reactive Power Limits



- The reactive power output of generators varies to maintain the terminal voltage; on a real generator this is done by the exciter
- To maintain higher voltages requires more reactive power
- Generators have reactive power limits, which are dependent upon the generator's MW output
- These limits must be considered during the power flow solution.

Generator Reactive Limits, cont'd



- During the power flow once a solution is obtained there is a check to make sure the generator reactive power output is within its limits
- If the reactive power is outside of the limits, fix Q at the max or min value, and resolve treating the generator as a PQ bus
 - this is know as "type-switching"
 - also need to check if a PQ generator can again regulate
- Rule of thumb: to raise system voltage we need to supply more vars

The N-R Power Flow: 5-bus Example

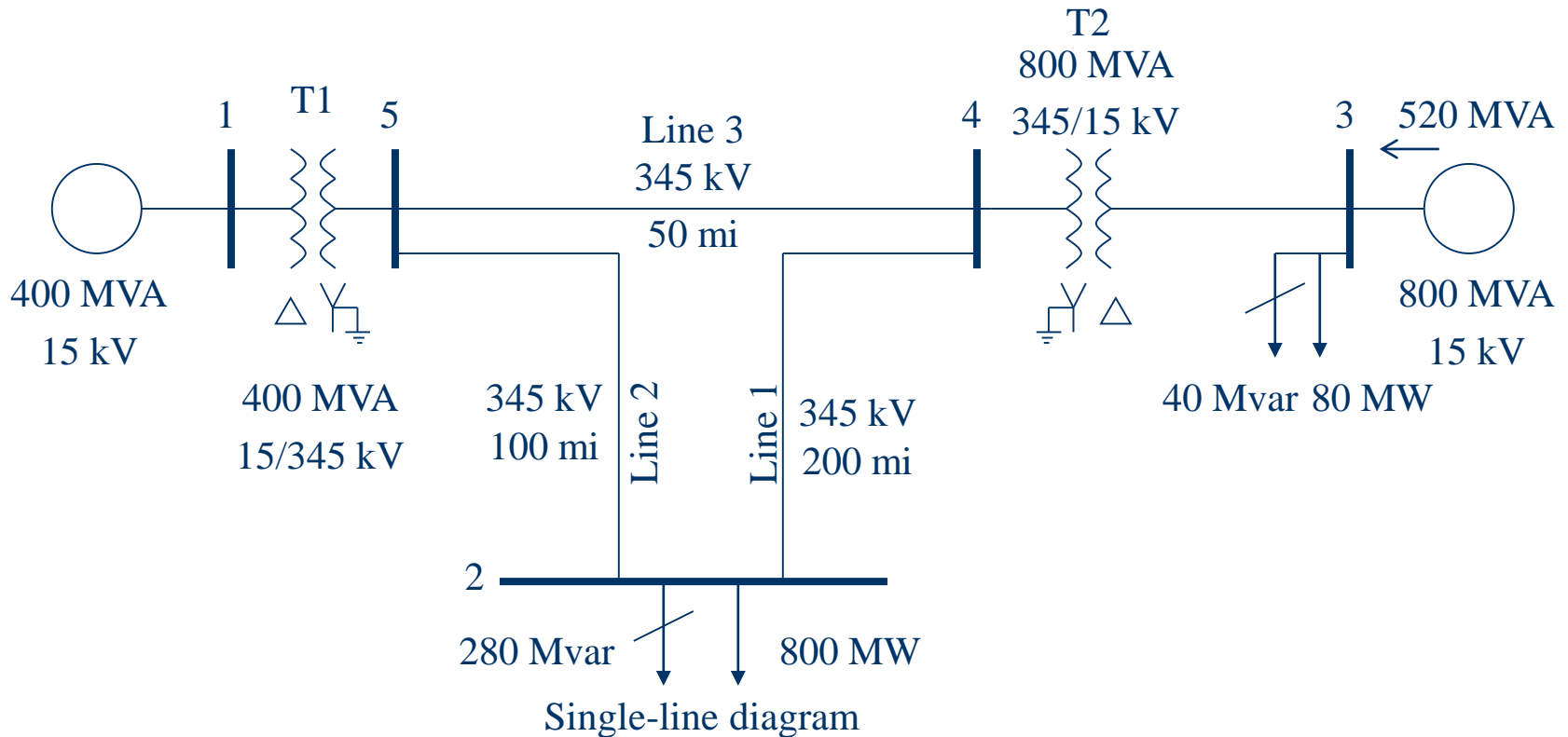

This five bus example is taken from Chapter 6 of Power System Analysis and Design by Glover, Overbye, and Sarma, 6th Edition, 2016

The N-R Power Flow: 5-bus Example



Table 1.
Bus input data

Bus	Type	V per unit	δ degrees	P_G per unit	Q_G per unit	P_L per unit	Q_L per unit	Q_{Gmax} per unit	Q_{Gmin} per unit
1	Swing	1.0	0	—	—	0	0	—	—
2	Load	—	—	0	0	8.0	2.8	—	—
3	Constant voltage	1.05	—	5.2	—	0.8	0.4	4.0	-2.8
4	Load	—	—	0	0	0	0	—	—
5	Load	—	—	0	0	0	0	—	—

Table 2.
Line input data

Bus-to-Bus	R' per unit	X' per unit	G' per unit	B' per unit	Maximum MVA per unit
2-4	0.0090	0.100	0	1.72	12.0
2-5	0.0045	0.050	0	0.88	12.0
4-5	0.00225	0.025	0	0.44	12.0

The N-R Power Flow: 5-bus Example



Table 3.
Transformer
input data

Bus-to-Bus	R per unit	X per unit	G_c per unit	B_m per unit	Maximum MVA per unit	Maximum TAP Setting per unit
1-5	0.00150	0.02	0	0	6.0	—
3-4	0.00075	0.01	0	0	10.0	—

Table 4. Input data
and unknowns

Bus	Input Data	Unknowns
1	$V_1 = 1.0, \delta_1 = 0$	P_1, Q_1
2	$P_2 = P_{G2} - P_{L2} = -8$ $Q_2 = Q_{G2} - Q_{L2} = -2.8$	V_2, δ_2
3	$V_3 = 1.05$ $P_3 = P_{G3} - P_{L3} = 4.4$	Q_3, δ_3
4	$P_4 = 0, Q_4 = 0$	V_4, δ_4
5	$P_5 = 0, Q_5 = 0$	V_5, δ_5

Five Bus Case Ybus



Case: Example6_9.pwb Status: Initialized | Simulator 13

Y Bus (Bus Admittance Matrix)

	Number	Name	Bus 1	Bus 2	Bus 3	Bus 4	Bus 5
1	1	One	$3.73 - j49.72$				$-3.73 + j49.72$
2	2	Two		$2.68 - j28.46$		$-0.89 + j9.92$	$-1.79 + j19.84$
3	3	Three			$7.46 - j99.44$	$-7.46 + j99.44$	
4	4	Four		$-0.89 + j9.92$	$-7.46 + j99.44$	$11.92 - j147.96$	$-3.57 + j39.68$
5	5	Five	$-3.73 + j49.72$	$-1.79 + j19.84$		$-3.57 + j39.68$	$9.09 - j108.58$

1.000 pu Two

PowerWorld Case Name: **GOS_FiveBus**

Ybus Calculation Details



Elements of Y_{bus} connected to bus 2

$$Y_{21} = Y_{23} = 0$$

$$Y_{24} = \frac{-1}{R'_{24} + jX'_{24}} = \frac{-1}{0.009 + j0.1} = -0.89276 + j9.91964 \text{ per unit}$$

$$Y_{25} = \frac{-1}{R'_{25} + jX'_{25}} = \frac{-1}{0.0045 + j0.05} = -1.78552 + j19.83932 \text{ per unit}$$

$$\begin{aligned} Y_{22} &= \frac{1}{R'_{24} + jX'_{24}} + \frac{1}{R'_{25} + jX'_{25}} + j\frac{B'_{24}}{2} + j\frac{B'_{25}}{2} \\ &= (0.89276 - j9.91964) + (1.78552 - j19.83932) + j\frac{1.72}{2} + j\frac{0.88}{2} \\ &= 2.67828 - j28.4590 = 28.5847 \angle -84.624^\circ \text{ per unit} \end{aligned}$$

Initial Bus Mismatches



Case: TD_2008_FiveBusExample.PWB Status: Initialized | Simulator 13

Case Information Draw Onlines Tools Options Add Ons Window

Mode Edit Mode Run Mode Model Explorer... Area/Zone Filters... Network Aggregation Filters, Expressions, etc... Simulator Options... Case Description... Case Summary... Custom Case Info... Power Flow List... Quick Power Flow List... AUX Export Format Desc... Bus View... Substation View... Open Windows

Model Explorer: Mismatches

Bus Real and Reactive Power Mismatches

Number	Name	Area Name	Type	Mismatch MW	Mismatch Mvar	Mismatch MV
1	Two	1	PQ	-800.00	-150.00	813.94
2	Four	1	PQ	37.29	605.20	606.35
3	Three	1	PV	400.85	0.00	400.85
4	Five	1	PQ	0.00	66.00	66.00
5	One	1	Slack	0.00	0.00	0.00

1.050 pu
0.000 Deg

1.000 pu
0.000 Deg

Two

800 MW

The mismatch of the Mvar power flow equation

Initial Power Flow Jacobian



Case: Example6_9.pwb Status: Initialized | Simulator 13

Case Information | Draw | Onelines | Tools | Options | Add Ons | Window

Run Mode | Model Explorer... | Area/Zone Filters... | Network | Aggregation | Filters, Expressions, etc | Simulator Options... | Case Description... | Power Flow List... | Case Summary... | Quick Power Flow List... | Custom Case Info... | AUX Export Format Desc... | Bus View... | Substation View... | Open Windows

Model Explorer: Power Flow Jacobian

Explore | Fields | Explore | Options

- Loads
- Mismatches
- Multi-Terminal DC
- Switched Shunts
- Three-Winding Transformer Controls
- Aggregations
- Areas
- Injection Groups
- Interfaces
- Islands
- Multi-Section Lines
- MW Transactions
- Nomograms
- Owners
- Substations
- Super Areas
- Tielines between Areas
- Tielines between Zones
- Transfer Directions
- Zones
- Solution Details
- Bus Zero-Impedance Br

Number	Name	Jacobian Equation	Angle Bus 2	Angle Bus 3	Angle Bus 4	Angle Bus 5	Volt Mag Bus 2	Volt Ma
1	2 Two	Real Power	29.76		-9.92	-19.84	2.68	
2	3 Three	Real Power		99.44	-99.44			
3	4 Four	Real Power	-9.92	-99.44	149.04	-39.68	-0.89	
4	5 Five	Real Power	-19.84		-39.68	109.24	-1.79	
5	2 Two	Reactive power	-2.68		0.89	1.79	27.16	
6	3 Three	Voltage Magnitude						
7	4 Four	Reactive power	0.89	7.46	-11.92	3.57	-9.92	
8	5 Five	Reactive power	1.79		3.57	-9.09	-19.84	

Jacobian Equation

Hand Calculation Details



$$\begin{aligned}\Delta P_2(0) &= P_2 - P_2(x) = P_2 - V_2(0)\{Y_{21}V_1 \cos[\delta_2(0) - \delta_1(0) - \theta_{21}] \\ &\quad + Y_{22}V_2 \cos[-\theta_{22}] + Y_{23}V_3 \cos[\delta_2(0) - \delta_3(0) - \theta_{23}] \\ &\quad + Y_{24}V_4 \cos[\delta_2(0) - \delta_4(0) - \theta_{24}] \\ &\quad + Y_{25}V_5 \cos[\delta_2(0) - \delta_5(0) - \theta_{25}]\} \\ &= -8.0 - 1.0\{28.5847(1.0) \cos(84.624^\circ) \\ &\quad + 9.95972(1.0) \cos(-95.143^\circ) \\ &\quad + 19.9159(1.0) \cos(-95.143^\circ)\} \\ &= -8.0 - (-2.89 \times 10^{-4}) = -7.99972 \text{ per unit}\end{aligned}$$

$$\begin{aligned}J_{1_{24}}(0) &= V_2(0)Y_{24}V_4(0) \sin[\delta_2(0) - \delta_4(0) - \theta_{24}] \\ &= (1.0)(9.95972)(1.0) \sin[-95.143^\circ] \\ &= -9.91964 \text{ per unit}\end{aligned}$$

Five Bus Power System Solved

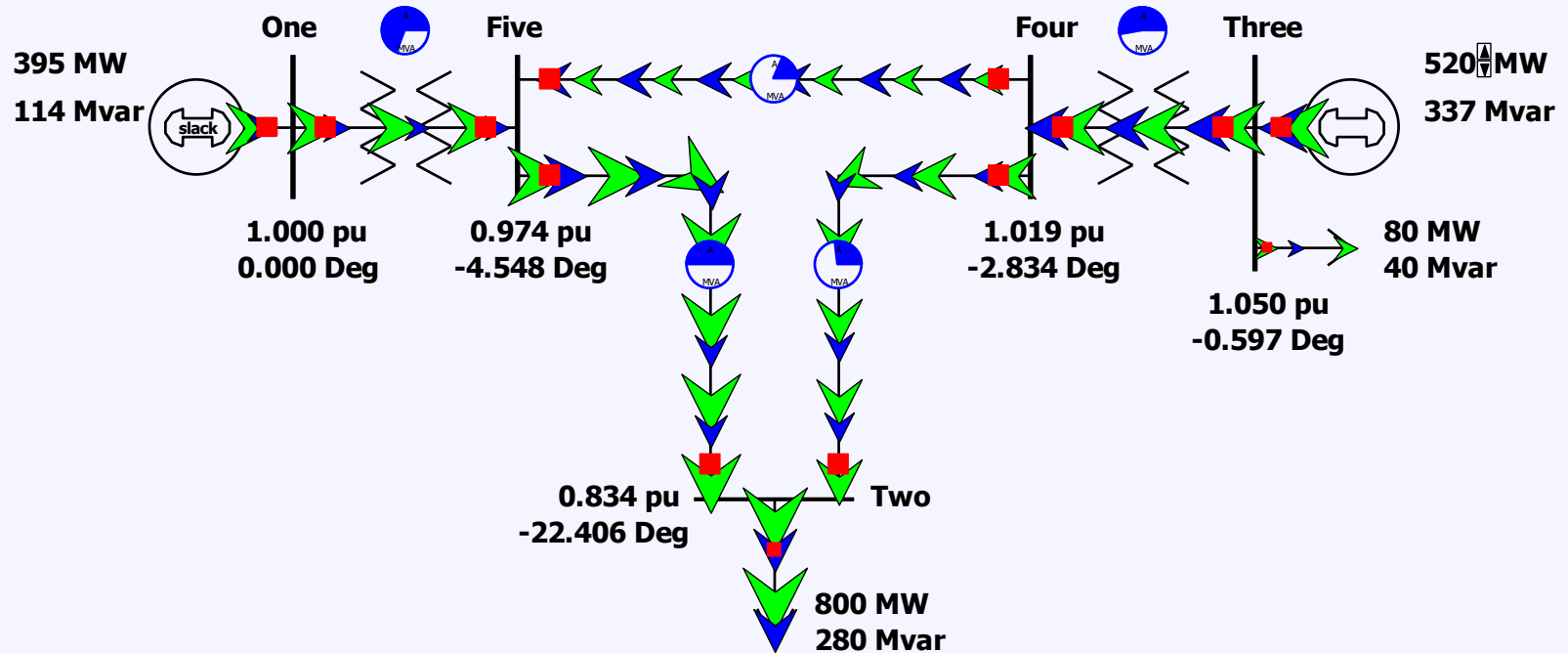

Voltage Control Example: 37 Buses

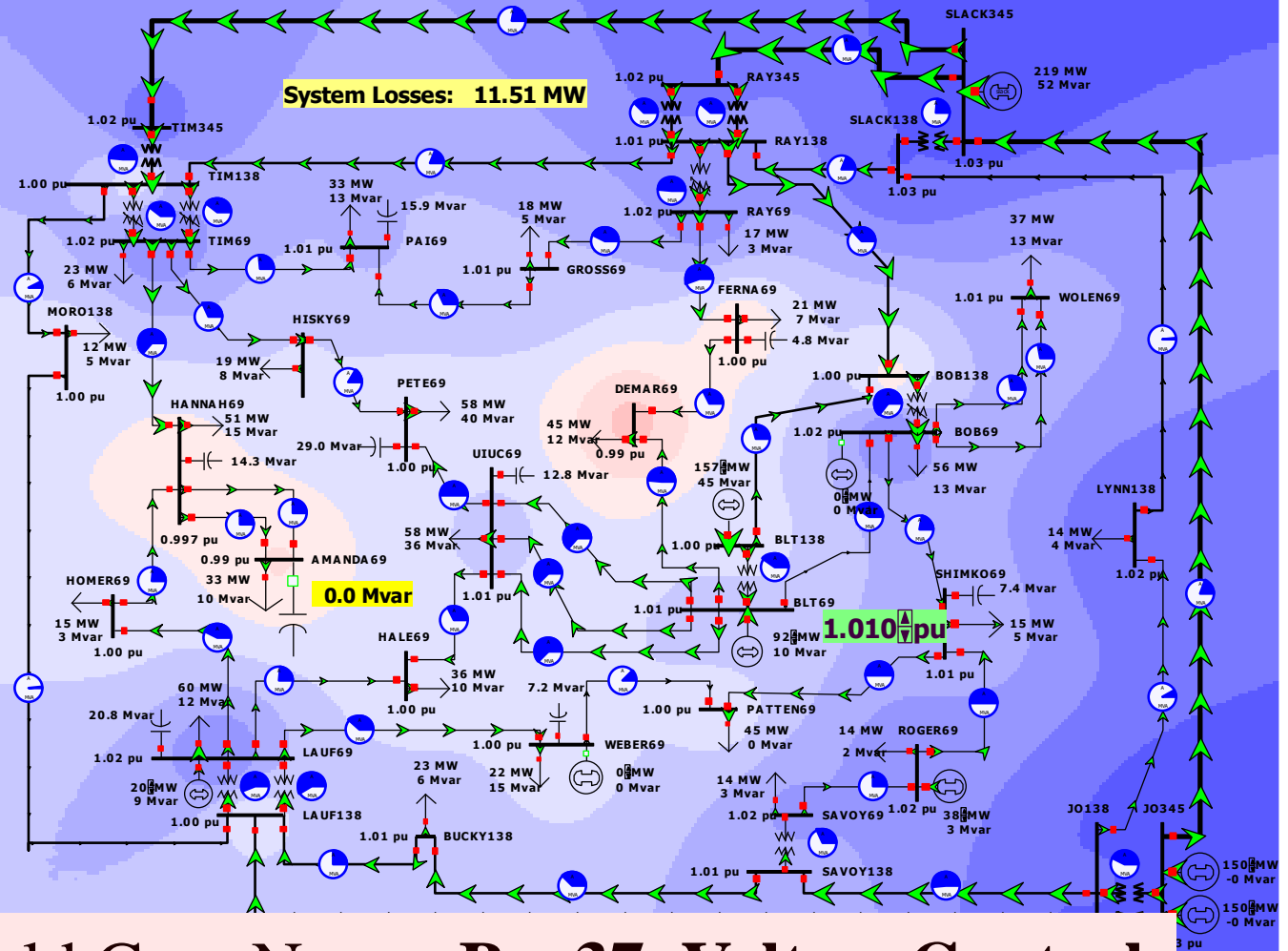
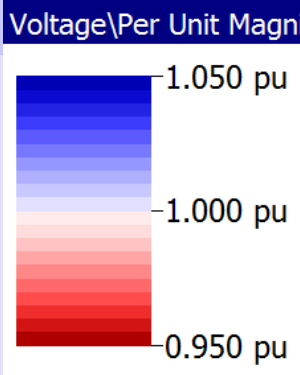

PowerWorld Case Name: **Bus37_VoltageControl**

Power System Operations Overview



- Goal is to provide an intuitive feel for power system operation
- Emphasis will be on the impact of the transmission system
- Introduce basic power flow concepts through small system examples

Power System Basics



- All power systems have three major components: Generation, Load and Transmission/Distribution.
- Generation: Creates electric power.
- Load: Consumes electric power.
- Transmission/Distribution: Transmits electric power from generation to load.
 - Lines/transformers operating at voltages above 100 kV are usually called the transmission system. The transmission system is usually networked.
 - Lines/transformers operating at voltages below 100 kV are usually called the distribution system (radial).

Large System Example: Texas 2000 Bus Synthetic System

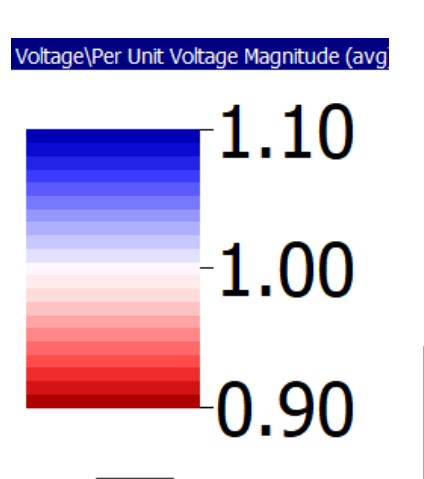

Texas Interconnect

Note: this grid is fictitious and doesn't represent the real Texas grid

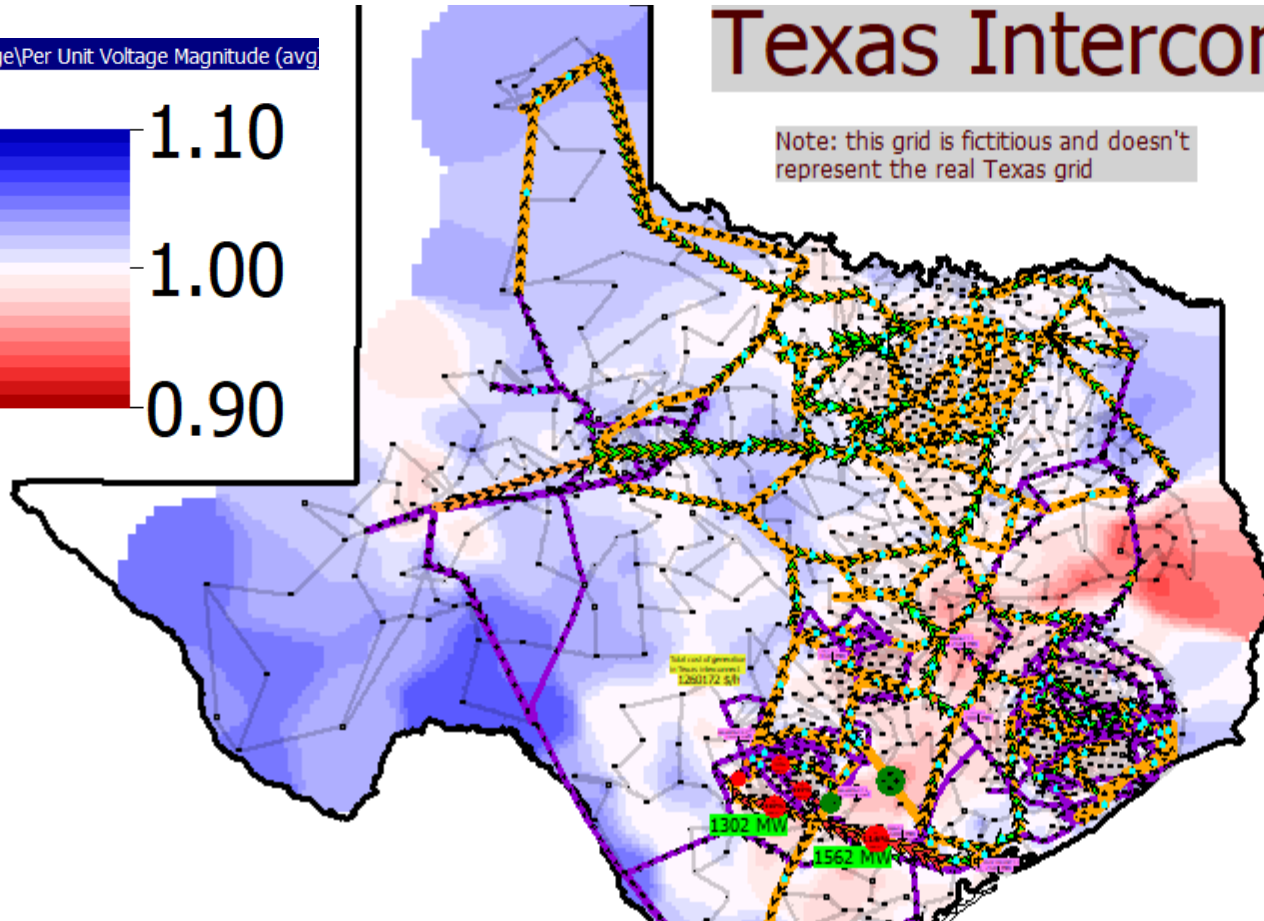

This case requires the commercial version of PowerWorld since the GOS Version is limited to 42 Buses

Three Bus PowerWorld Simulator Case



PowerWorld Case Name: **B3Slow**

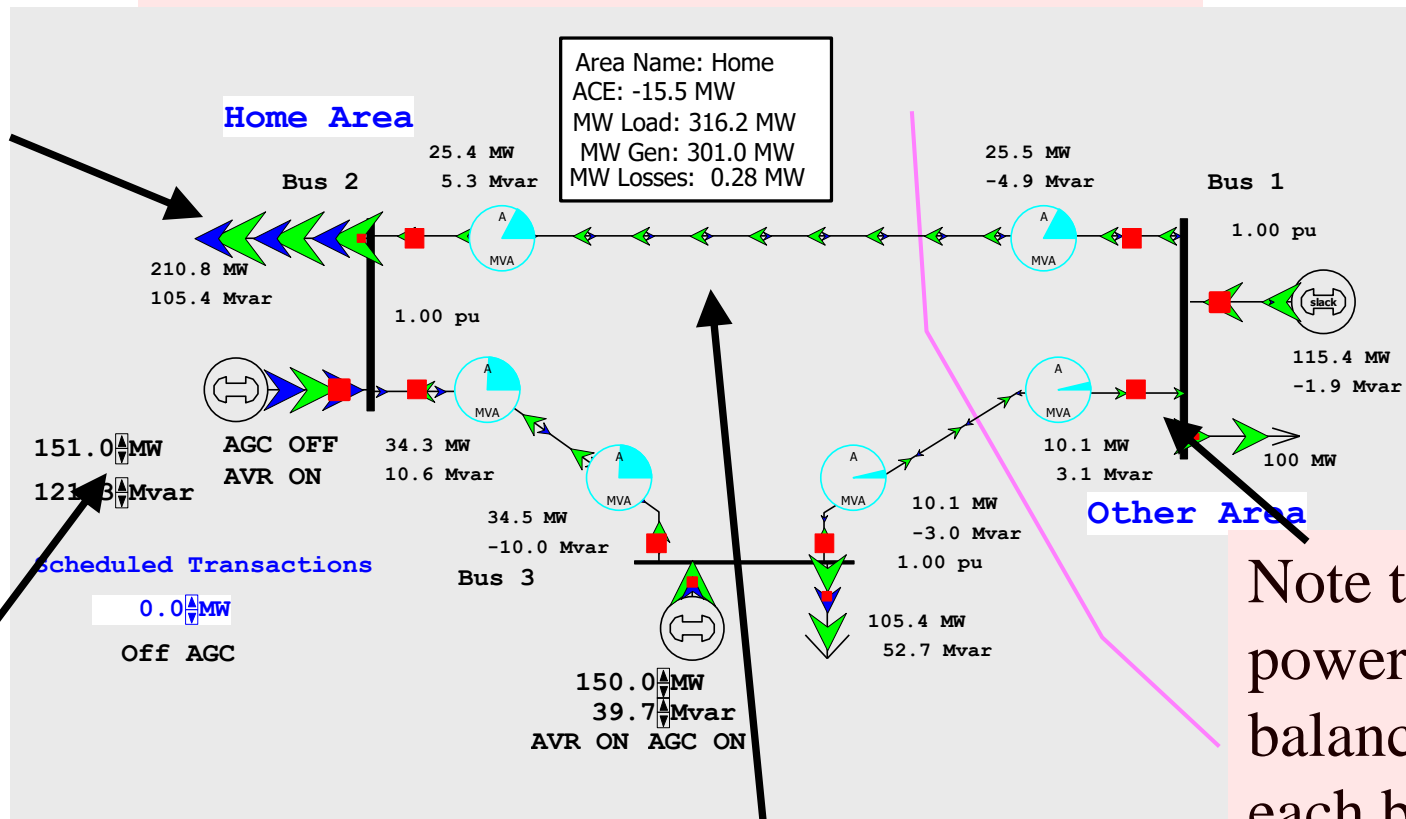

Load with green arrows indicating amount of MW flow

Used to control output of generator

Note the power balance at each bus

Direction of green arrow is used to indicate direction of real power (MW) flow; the blue arrows show the reactive power

Basic Power Control



- Opening a circuit breaker causes the power flow to instantaneously (nearly) change.
- No other way to directly control power flow in a transmission line.
- By changing generation we can indirectly change this flow.
- Power flow in transmission line is limited by heating considerations
- Losses ($I^2 R$) can heat up the line, causing it to sag.

Modeling Consideration – Change is Not Really Instantaneous!



- The change isn't really instantaneous because of propagation delays, which are near the speed of light; there also wave reflection issues
 - This is covered in ECEN 667

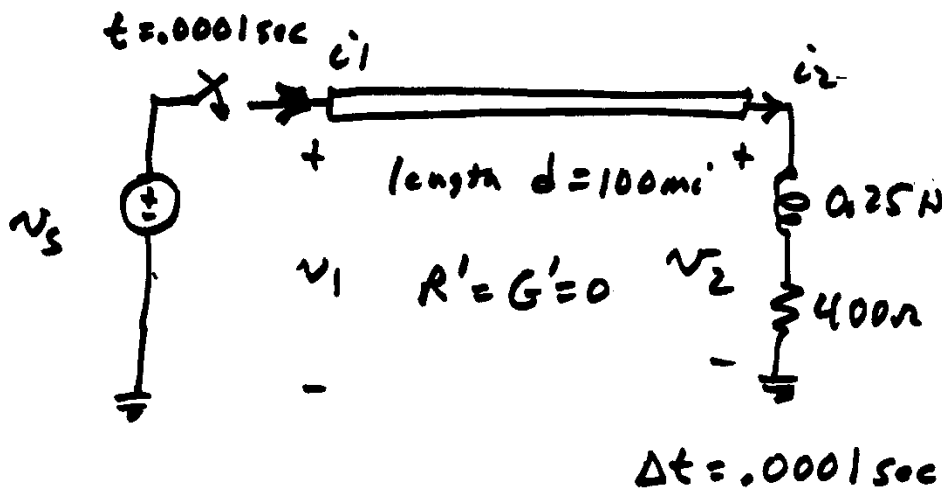

Red is the v_s end, green the v_2 end

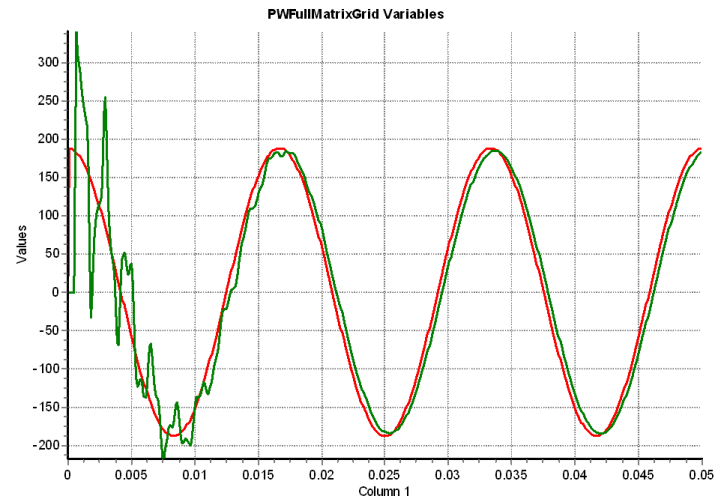

Transmission Line Limits



- Power flow in transmission line is limited by heating considerations.
- Losses ($I^2 R$) can heat up the line, causing it to sag.
- Each line has a limit; many utilities use winter/summer limits.

Overloaded Transmission Line

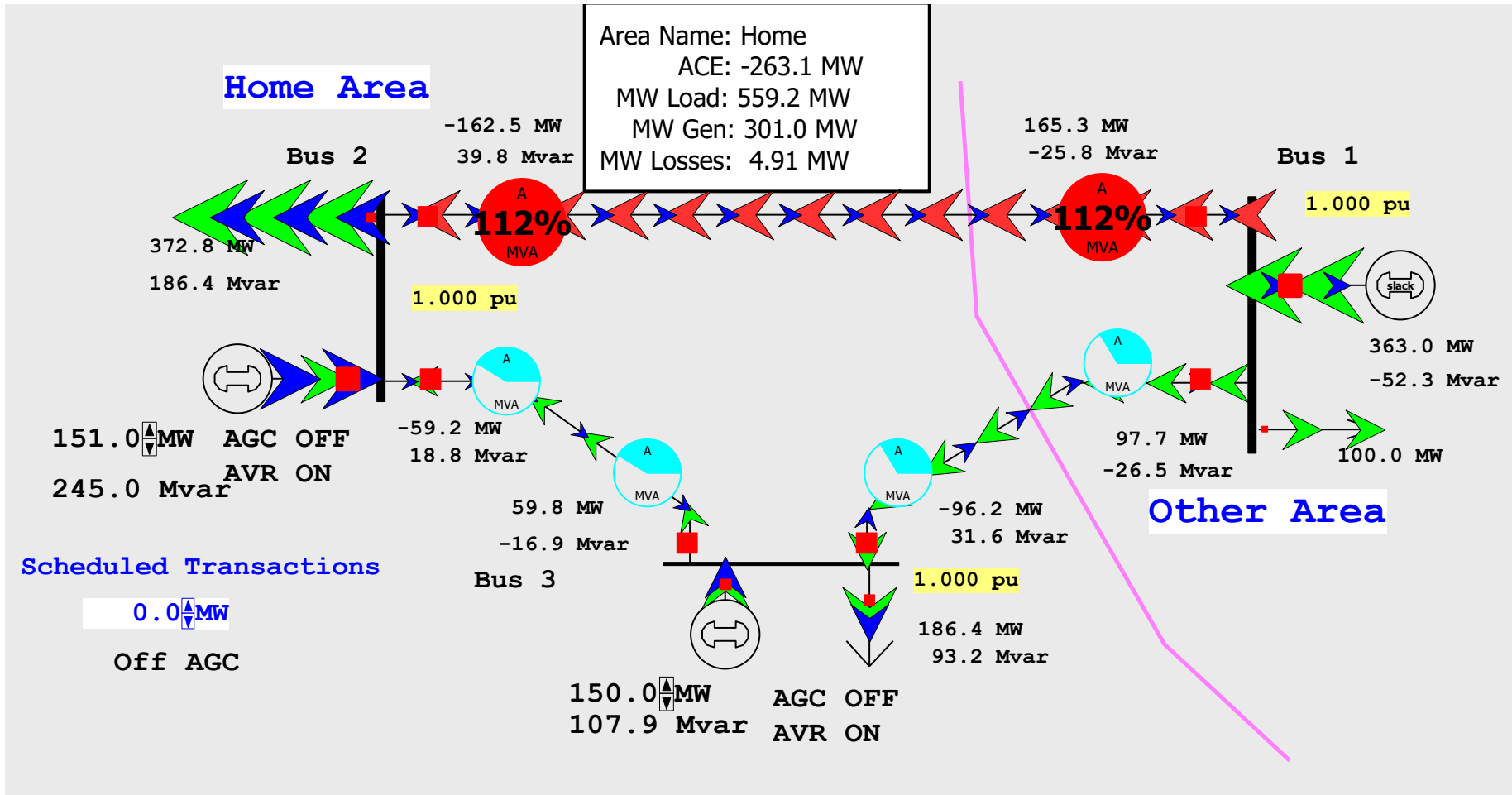

Interconnected Operation Balancing Authority (BA) Areas



- North American Eastern and Western grids are divided into balancing authority areas (BA)
 - Often just called an area
- Transmission lines that join two areas are known as tie-lines.
- The net power out of an area is the sum of the flow on its tie-lines.
- The flow out of an area is equal to

$$\text{total gen} - \text{total load} - \text{total losses} = \text{tie-flow}$$

US Balancing Authorities



U.S. electric power regions

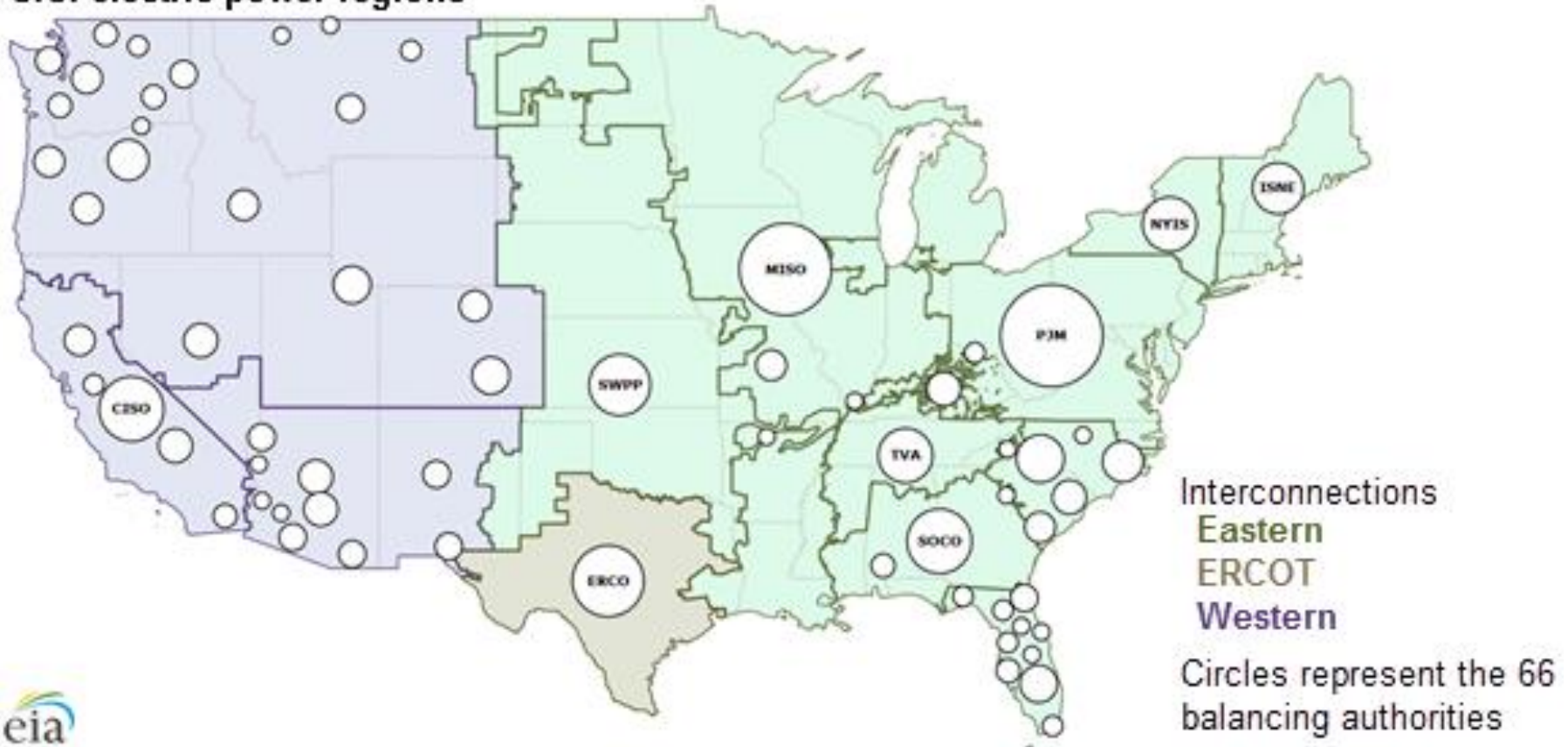

Area Control Error (ACE)



- The area control error is the difference between the actual flow out of an area, and the scheduled flow
 - ACE also includes a frequency component that we will probably consider later in the semester
- Ideally the ACE should always be zero
- Because the load is constantly changing, each utility (or ISO) must constantly change its generation to “chase” the ACE
- ACE was originally computed by utilities; increasingly it is computed by larger organizations such as ISOs

Automatic Generation Control



- Most utilities (ISOs) use automatic generation control (AGC) to automatically change their generation to keep their ACE close to zero.
- Usually the control center calculates ACE based upon tie-line flows; then the AGC module sends control signals out to the generators every couple seconds.

Three Bus Case on AGC

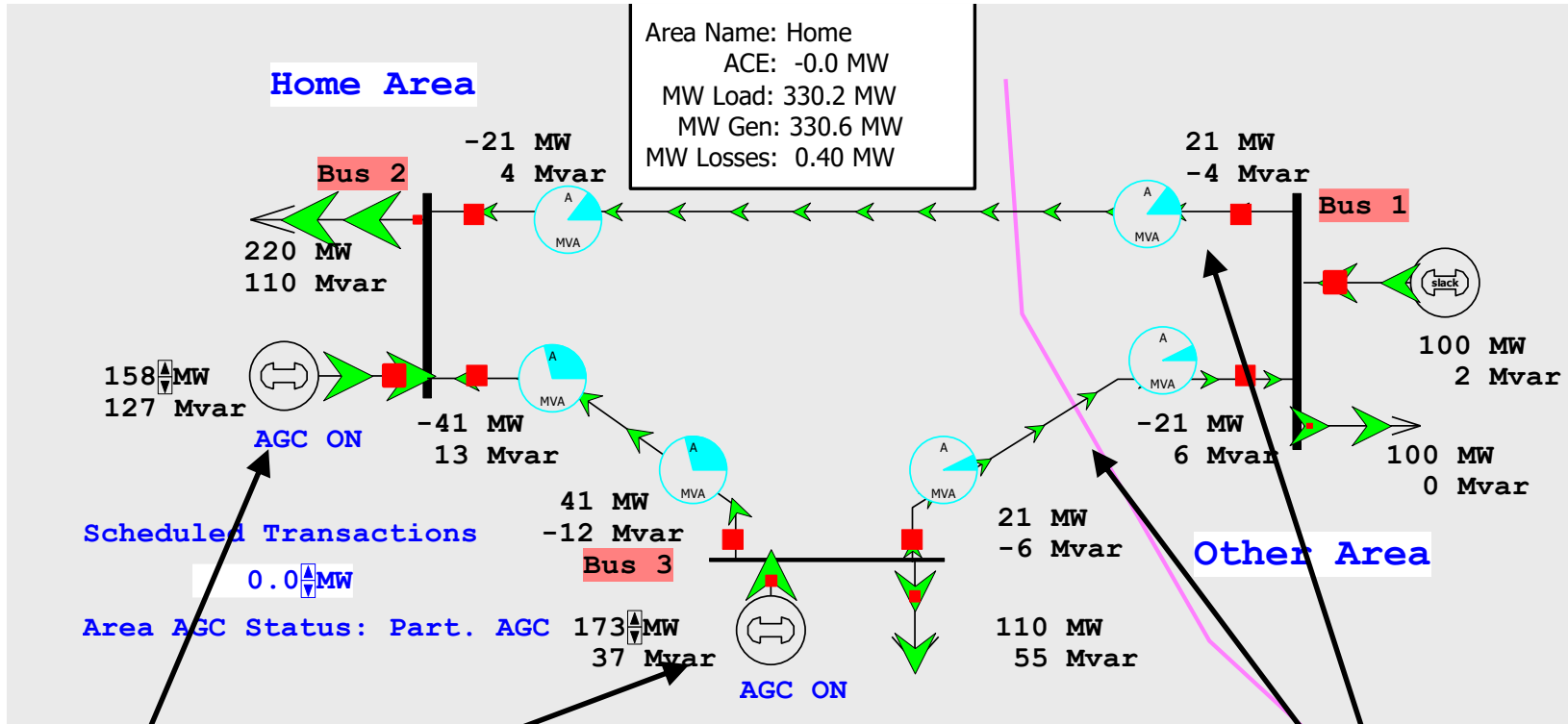

Generation is automatically changed to match change in load

Net tie flow is close to zero