

Creation of Synthetic Electric Grid Models for Transient Stability Studies

Ti Xu[†], Adam B. Birchfield[‡], Komal S. Shetye[†] and Thomas J. Overbye[‡]

[†] Department of Electrical and Computer Engineering, University of Illinois, Urbana, IL, USA, 61801

[‡]Department of Electrical and Computer Engineering, Texas A&M University, College Station, TX, USA, 77843

Abstract—Transient stability is the ability of power systems to maintain synchronism when subjected to a severe transient disturbance. Test systems are widely used in power system transient stability area for teaching, training, and research purposes. Even though several small-scale test cases are available to the public, access to actual large-scale power system models is limited due to security issue. Synthetic network modelling methodology has addressed this issue and aims to generate test systems that are completely fictitious but capable of representing characteristic features of actual power grids. Previous work has proposed an automated algorithm to create synthetic transmission network base models, with statistics similar to those of actual power grids. Thus, this paper outlines an approach to extend synthetic network base models for transient stability studies. Statistics summarised from actual models are the basics to assign appropriate models with appropriate parameters to each generator. A parameter validation and model tuning process is also proposed in this paper. The construction of dynamic cases for two synthetic network models is presented for illustrations.

Index Terms—power system transient stability, synthetic networks, generator dynamics, model validation

I. INTRODUCTION

Transient stability in power systems refers to the ability of a synchronous power system to return to stable conditions and maintain its synchronism following a relatively large disturbance [1], [2]. It is very important for power engineers and system operators to be aware of system transient stability conditions. Transient stability analysis is usually performed using power system dynamic models of different scales. The objective of technical report [3] is to develop several benchmark models that could be used on small signal analysis for comparisons of different methods and stabilizer tuning algorithms. Six models are presented in [3] with number of buses(generators) ranging from 6 (3) to 68 (16). All those models are completely fictitious or high-level summaries of actual grid models. A group of researchers have also extended and archived IEEE test systems with dynamic model data appropriate for performing time-domain simulations [4], [5]. European Network of Transmission System Operators for Electricity and the University of Erlangen-Nuremberg collaborated to create a dynamic study model of the entire continental Europe power system. Even though the dynamic study model of the entire continental Europe power system is documented

This work was supported in part by the U.S. Department of Energy Advanced Research Projects Agency-Energy (ARPA-E) under the GRID DATA project, and in part by the U.S. Department of Energy Consortium for Electric Reliability Technology Solutions (CERTS).

in [6], the access to the data is restricted and any party is required to sign a Confidentiality Undertaking after which access can be provided.

Actual large-scale power system models are used to simulate system frequency response so as to provide realistic, insightful results on power system transient stability [6]–[8]. However, legitimate security concerns severely limit the disclosure of information about actual system models. The lack of full public access to actual power system models limits the global power system community’s ability to engage in research related to power system transient stability. Several test cases with dynamics are available to the public, but there is limited access to actual large-scale power system models that represent the complexity of today’s electricity grids for dynamic studies. As such, this paper addresses the need to build synthetic large-scale system dynamic models for transient stability studies.

Synthetic networks have no relation to the actual electric grid in their geographic location, thus they pose no security concern and are public for comparing results among researchers. This paper builds on previous works [9], [10] to extend a synthetic network base case [11] with generator dynamic models. The proposed approach applies statistics summarized from one Eastern Interconnection (EI) case to assign appropriate parameters to generators. For each model (machine, governor, exciter and/or stabilizer), we categorize model parameters into two groups with discretely or continuously distributed parameters. Typical values for each discrete parameter are assigned to synthetic generators in probabilities proportional to total capacity of actual generators adopting those values in the EI case. As for a continuous parameter, a random value is drawn from its possible range obtained from actual models and assigned to a synthetic generator. Model validation and parameter tuning procedure is then proposed to adjust model parameters such that each parameter value is reasonable and each model has satisfactory test performances. Generator cost models are also included in the way described in [12] for unit commitment and economic dispatch purposes. The proposed approach is applied to build 200-bus and 500-bus test cases on the footprint of the central Illinois and South Carolina, respectively.

In this paper, four more sections come as follows. In Section II, an algorithm is developed to automatically complete the parameter determination for adding dynamics to each synthetic generator. Model validation and parameter tuning process is proposed in Section III. Section IV provides illustrative examples, and Section V concludes this paper and future work

direction.

II. EXTENSION OF SYNTHETIC NETWORK BASE MODELS WITH GENERATOR DYNAMICS

Each generator in a synthetic network base model has its generation capacity and fuel type defined in the network building process. These two parameters are the basics to add synthetic dynamic models of synthetic generators' machine, turbine-governor, exciter, and/or stabilizer models. This section focuses on determining appropriate model parameters, as briefly shown in Fig.1, and then presents detailed statistical analysis on selected machine / governor / exciter / stabilizer models.

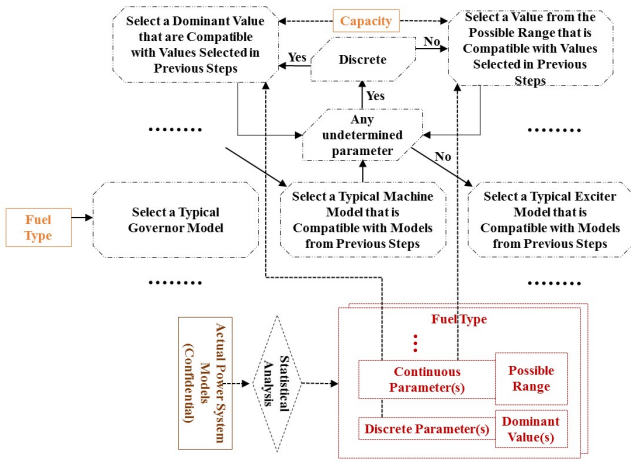

Fig. 1. Statistical extension process to include generator dynamic models

A. Statistical Extension Process

For each discrete parameter, we are interested in those values that appear much more frequently than others in actual system models. One value is defined as "dominant" if the percentage of models adopting that value is over some threshold value. For any model m , each discrete parameter may have multiple dominant values, which are assigned to synthetic generators equipped with model m by probabilities proportional to their relative percentages.

Some parameters have discrete distributions, while some other parameters are continuously distributed over some ranges. A possible range of values for each continuous parameter is found based on statistics summarized from actual system models. For any model m with a continuous parameter c , values are statistically selected from c 's possible range and assigned to synthetic generators equipped with model m .

Some parameters are depending on fuel type and/or generator capacity, and some other parameters have strong correlations. Such relationships are also summarized from actual power system models and used to facilitate parameter assignment procedure. For instance, given any model m with two strongly correlated continuous parameters c_1 and c_2 , one value for c_1 is statistically determined first and the remaining one c_2 is assigned with a value computed using c_1 value and their correlations observed in actual system models.

Some parameters are not correlated with each other, but there are some limitations on statistically assigning values to them. Those limitations are used to exclude impossible combination of model parameters. For example, in GENROU model, $X_d'' < X_d'$ and $X_d' > X_l$ should be enforced as hard constraints. In general, every model parameter should be in an acceptable or reasonable range [13], [14]. Report [15] establishes a complete list of models with an acceptable range for each model parameter. The ranges in [13], [14] are used to validate the assigned parameter values. If any limit is violated, a minimum number of parameters are set to different values to satisfy the violated limit(s) without violating others.

Here, we use coal-fueled power plants as an illustrative example and only consider one typical model for machine(GENROU), governor(TGOV1) and exciter(SEXS).

B. Machine Model - GENROU

Fig.2 shows the block diagram for machine model - GENROU. As observed in Fig.3, the machine inertia value is depending the generator capacity. The orange line encloses the region where possible inertia values are drawn from for coal units. For instance, if a synthetic generator have a 500-MW generation capacity, an inertia value is randomly picked from the range [2,4].

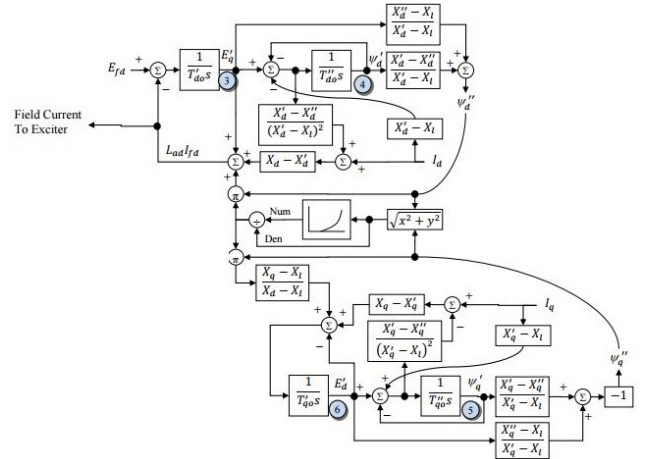

Fig. 2. Block diagram for machine model GENROU

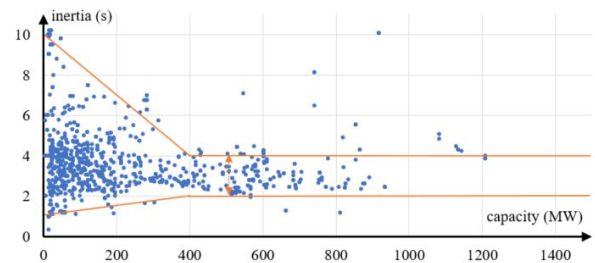

Fig. 3. Dependence of machine inertia on generator capacity for coal units

Next, we care about finding values for X_d , X_q , X_d' , X_q' , X_d'' and X_l . Three well-fit linear regressions are found for X_d and X_q , X_d'' and X_l , as well as X_d' and X_q'' (as displayed in

Fig.4(a)-(c)). Statistical analysis also shows the dependence of X'_d on X_d and X'_q on X_q (as displayed in Fig.4(d)-(e)). Till now, with three linear relations and two statistical dependences, only one value among X_d , X_q , X'_d , X'_q , X''_d and X_l is needed to determine all their values. This sub-section start with the dependence of X_d on generator capacity for coal units (as displayed in Fig.4(f)). For instance, given a 500-MW coal plant:

- Based on Fig.4(f), we random draw a value from [1.60,2.33] for X_d ;
- Based on Fig.4(a) and the value X_d , we apply the observed linear relation to determine a value for X_q ;
- Based on Fig.4(d), we random draw a value from a possible range conditioned on the value X_d for X'_d ;
- Based on Fig.4(e), we random draw a value from a possible range conditioned on the value X_q for X'_q ;
- Based on Fig.4(c) and the value X'_d , we apply the observed linear relation to determine a value for X''_d ;
- Based on Fig.4(b) and the value X''_d , we apply the observed linear relation to determine a value for X_l .

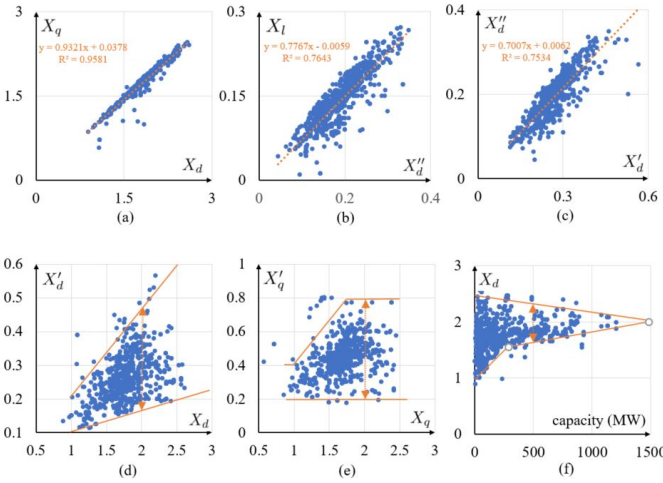

Fig. 4. Statistics on X_d , X_q , X'_d , X'_q , X''_d and X_l in GENROU model for coal units

As for time constants T'_{do} , T'_{qo} , T''_{do} and T''_{qo} , we did not observe any strong correlation among any two of them, or any dependence on other already-defined parameters. Thus, we can determine a value for each time constant individually. T'_{do} is randomly dram from the range [4,10]; T'_{qo} is randomly dram from the range [0.3,1.5]; T''_{do} is randomly dram from the range [0.02,0.06]; T''_{qo} is randomly dram from the range [0.04,0.08]. The range of each parameter is determined based on the observation from actual models.

As shown in Fig.5(a), for the saturation functions, a linear regression $S_{12} = 1.9988S_1 + 0.2355$ (with R-squared value to be 0.8) is observed and then used in the parameter assignment process. The approximated cumulative distribution function (c.d.f.) in Fig.5(b) is applied to randomly draw a value from the range [0.02,0.2] for S_1 .

At last, we set R_a , R_{comp} and X_{comp} to zero according to the statistics summarized from the EI case.

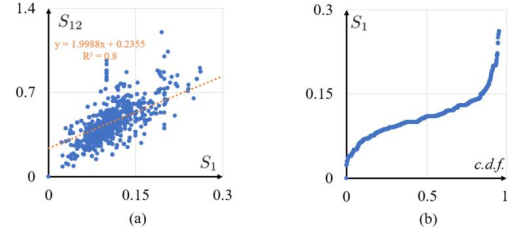

Fig. 5. Statistics on saturation function coefficients in GENROU model for coal units

C. Governor Model - TGOV1

Fig.6 shows the block diagram for turbine-governor model - TGOV1. The TGOV1 model is a simple steam turbine model and represents the turbine-governor droop (R), the main steam control valve motion and limits (T_1 , V_{MAX} , V_{MIN}) and has a single lead-lag block (T_2 , T_3) representing the time constants associated with the motion of the steam through the reheater and turbine stages. The ratio, T_2/T_3 , equals the fraction of the turbine power that is developed by the high-pressure turbine stage and T_3 is the reheater time constant. Since TGOV1 is the simplest governor model and many other models are build on or extended from TGOV1 by adding more details [13], we collect statistics (on T_1 , T_2 , T_3 , R , V_{MAX} , V_{MIN} and D_t) from TGOV1 and some other governor models for coal units to add parameter variations.

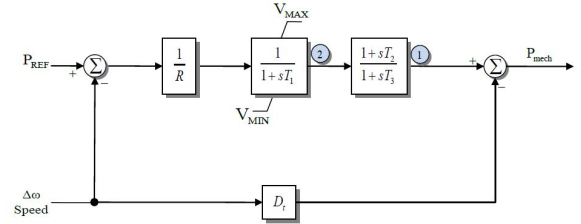

Fig. 6. Block diagram for governor model TGOV1

Fig.7 summarizes the statistics on T_1 , T_2 , T_3 and R of TGOV1 model for coal units. As such, a constant value 0.05 is set for R . 0.5 and 0.2 are assigned to T_1 by probabilities of 0.6 and 0.1, respectively, while the remaining 30% of T_1 are randomly drawn from [0.1,0.5]. T_2/T_3 ratio has two typical values: 0.3 (about 70%) and about 0.3333 (about 20%). In addition, T_2/T_3 ratio value distribution has trivial correlation with T_2 or T_3 . Thus, we randomly assign 0.3 and 0.3333 as the T_2/T_3 ratio to TGOV1 models by probabilities of 0.77 and 0.23, respectively. Around 80% of T_2 equals to either 2.1(44%), 2.5(11%) or 3 (25%). We randomly assign 2.1, 2.5 and 3 to TGOV1 models by probabilities of 0.55, 0.13 and 0.32, respectively. T_1 is not statistically correlated with T_2 and T_3 . Thus, the three random assignments can be performed individually. As last, V_{MAX} is set to 1 since over 90% of studied models in the EI model case V_{MAX} of 1 and V_{MIN} is set to 0 since over 90% of studied models in the EI model case V_{MIN} of 0. Over 95% of D_t of studied models in the EI case is 0, thus the D_t in the synthetic case is set to 0.

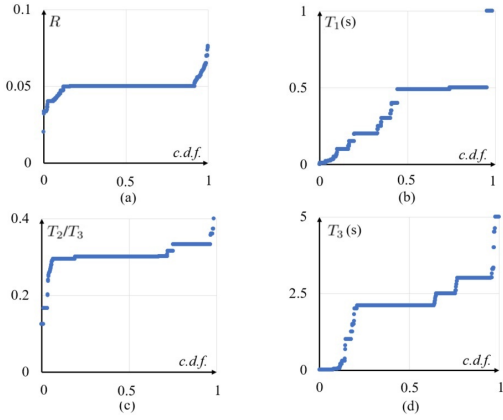

Fig. 7. Statistics on T_1 , T_2 , T_3 and R in TGOV1 model for coal units

D. Exciter Model - SEXS

Fig.8 shows the block diagram for exciter model SEXS. Model SEXS represents no specific type of excitation system, but rather the general characteristics of a wide variety of properly tuned excitation systems. To add parameter variations, statistics from both SEXS and EXST1 models are used.

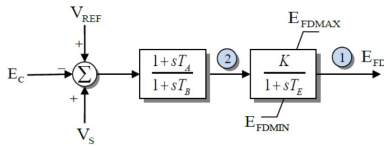

Fig. 8. Block diagram for exciter model SEXS

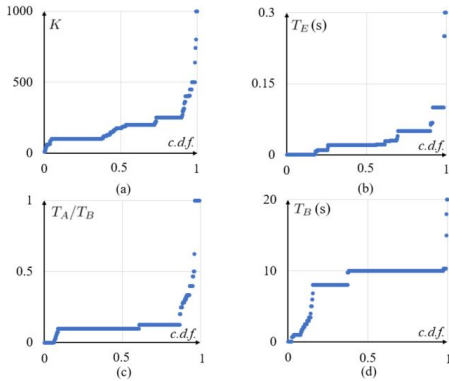

Fig. 9. Statistics on T_A , T_B , T_E and K in SEXS model for coal units

The parameter assignment process works in a way similar to those in Sections II.A and II.B. According to Fig.9(a), 35% of synthetic SEXS models are assigned with $K=100$, 20% are assigned with $K=200$, 20% are assigned with $K=250$, and the remaining 25% are assigned with values uniformly drawn from [100,200]. Similarly, we assign about 50% of synthetic SEXS models with $T_E=0.02$, 35% of them with $T_E=0.05$ and the remaining to have $T_E=0.1$. Except value of zero, there are about 2/3 models with $T_A/T_B=0.1$ and 1/3 of them with

$T_A/T_B=0.125$. Thus, we randomly assign 0.1 and 0.125 to T_A/T_B by probabilities of 0.67 and 0.33, respectively. 10 and 8 are randomly assigned to the T_B values by probabilities of 0.75 and 0.25, respectively. This is because 10 (around 58%) and 8 (around 21%) are two most common values for T_B . $E_{FDMIN} = -4$ ($E_{FDMAX} = 5$) is considered since over 80% (86%) of models in the EI case have E_{FDMIN} of -4 (E_{FDMAX} of 5).

III. MODEL TUNING AND VALIDATION

Section II describes a prototype procedure to extend initial synthetic network models with generator dynamics. The statistical parameter assignment procedure aims to match statistics from actual models, followed a model validation and tuning process discussed in this section.

GENROU, GENSAI, GENROE, GENSAE, GENDCO, GENCLS, GENTRA, FRECHG for Applicable Data

$1 < H < 10$	$0 < S_{1,0}$
$0 \leq D < 3$	$S_{1,0} < S_{1,2}$
$1 < T_{d0} < 10$	$x'_d = \text{IMAG}(\text{ZSORCE})$ for GENROU, GENSAI, GENDCO, FRECHG
$4 \times \text{DELTA} < T_{d0} < 0.2$	$0.2 \leq T_{q0} \leq 1.5$
$4 \times \text{DELTA} < T_{q0} < 0.2$	$x'_q < x_q$
$x_d < 2.5$	$x'_d < x'_q$
$x'_d < 0.5 \times x_d$	$x''_d < x'_q$
$x_q < x_d$	$0.025 \leq T_a \leq 0.1$
$x'_d < x_q$ for GENSAI, FRECHG and GENTRA only	$x'_d = \text{IMAG}(\text{ZSORCE})$ for GENTRA
$x''_d < x'_d$	$0 < \text{Acceleration Factor} \leq 1.0$
$x_1 < x'_d$	$H_1 \times \text{MBASE}_1 = H_2 \times \text{MBASE}_2$ for FRECHG

COMP

$$0 < |X_0| < 1$$

COMPCC

$$X_1 > 0 \text{ and } X_2 > 0$$

TGOV1

$0 < R < 0.1$	$0 < T_2$
$4 \times \text{DELTA} < T_1 < 0.5$	$4 \times \text{DELTA} < T_3 < 10.0$
$0.5 < V_{MAX} < 1.2$	$T_2 < T_3/2.0$
$V_{MIN} < V_{MAX}$	$0 \leq D_1 < 0.5$
$0 \leq V_{MIN} < 1.0$	

SEXS

$0.05 < T_A/T_B < 1$	$5 \leq K \times T_A/T_B \leq 15$
$5 < T_B < 20$	$E_{MIN} = 0$
$20 < K \leq 100$	$3 \leq E_{MAX} \leq 6$
$0 \leq T_E < 0.5$	

Fig. 10. Acceptable ranges for GENROU, TGOV1 and SEXS parameters

Every model parameter should be in an acceptable or reasonable range [13], [14]. Report [15] establishes a complete list of models with an acceptable range for each model parameter. The ranges shown in Fig.10 is used to validate the assigned parameter values. If any limit is violated, a minimum number of parameters are set to different values to satisfy the violated limit without violating others.

Each machine with its control elements needs to meet specified performance criteria in designed tests [16]–[18]. For excitation systems, frequency responses of the automatic voltage regulator control loop are of primary interest [17], [18]. Both open-loop and closed-loop frequency responses are

useful for assessing the performance of feedback control systems. Typical open-loop and closed-loop frequency responses of an excitation control system with the synchronous machine open-circuited are shown in Fig.11 and Fig.12.

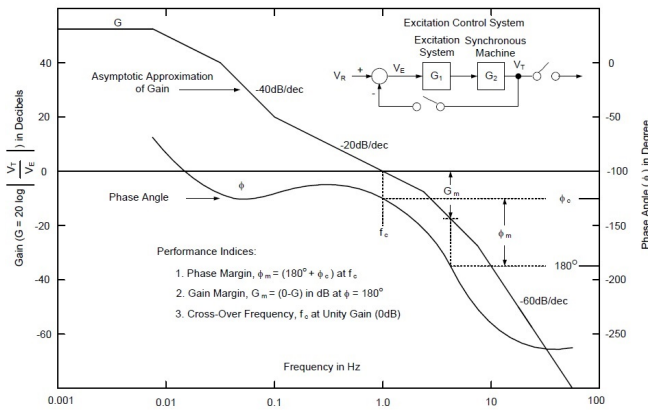

Fig. 11. Typical open-loop frequency responses of an excitation control system with the synchronous machine open-circuited [17]

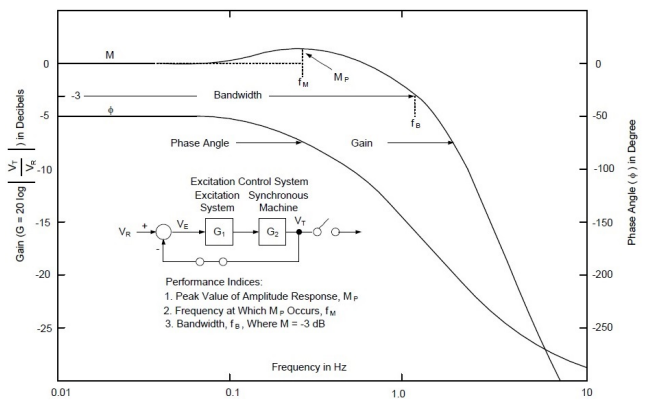

Fig. 12. Typical closed-loop frequency responses of an excitation control system with the synchronous machine open-circuited [17]

Relative stability of a feedback control system is measured in terms of the gain and phase margins. In this paper, an excitation control system with a gain margin above 6 dB and a phase margin above 40° is recommended. In addition, the bandwidth ω_B , the peak value M_p (a measure of relative stability.) of the gain characteristic, and the frequency ω_c at the peak value M_p are usually selected as the closed-loop frequency response characteristics. For a well-designed excitation control system, $1.1 < M_p < 1.6$ is preferred.

Both open-loop and closed-loop frequency responses are evaluated for each generator. Given a generator that does not meet at least one of the recommended performance criteria:

- If violation is small, some exciter parameters will be changed by a manual adjustment process;
- If violation is significant, we re-run the parameter process proposed and re-validate/tune the generated parameters.

IV. ILLUSTRATIVE EXAMPLE

Once the synthetic network base models with buses, generators, loads, transformers, and transmission lines, has a feasible ac power flow solution, the proposed approach is applied to improve the realism of those models by including data necessary for transient stability studies. For illustrations, this section presents two synthetic network dynamic cases, which are available at [11].

A. ACTIVSg200 Case

This section discusses in detail on modeling dynamics for a 200-bus case with two voltage levels (230/115 kV) on the footprint of Central Illinois. As shown in Fig.13, this case represents one single area covering fourteen counties and 1.1 million people. This case contains 49 generators with a total capacity of 3543 MW and the load level is set at 2229 MW and 653 MVar. This case has a flat start with well-damped and stable performances in selected N-1 contingencies (loss of generation or three-phase fault at one bus). Some transient stability simulation results are displayed in Fig.14.

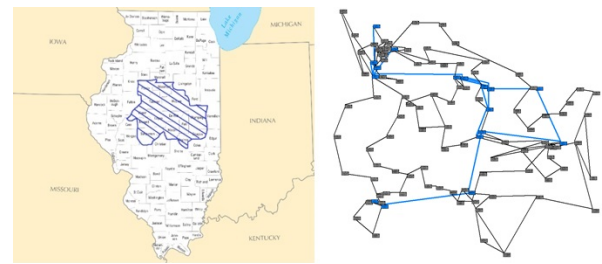

Fig. 13. Geographic footprint and one-line diagram of the 200-bus case

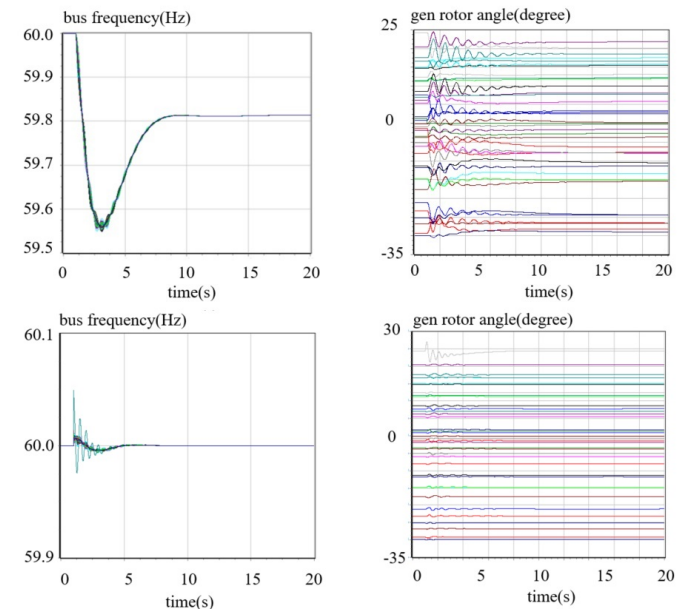

Fig. 14. Selected simulation results (upper: loss of a 296-MW generation at 1s; lower: a three-phase fault on bus 135 at 1s (cleared in 0.01s))

B. ACTIVSg500 Case

As shown in Fig.15, the second case is built on the footprint of the western South Carolina, which covers about 21 counties and serves around 2.6 million people. 90 generators in this case has a total capacity of 12188 MW. The synthetic system has two voltage levels (345/138 kV). Extensive simulations will be performed to verify that this case has a flat start with well-damped and stable performances in selected N-1 contingencies (loss of generation or three-phase fault at one bus). Compared to the previous 200-bus model with simply GENROU, TGOV1 and SEXS (all statistical analysis are performed on coal units), modeling dynamics for ACTIVSg500 case are different in two aspects:

- Three fuel types are considered when modeling dynamics - coal, gas and hydro - with no wind in this case and all other units treated as coal units;
- A fixed set of machine, exciter and governor models with various parameters: coal - GENROU, TGOV1, SEXS; gas - GENROU, GAST, SEXS; hydro - GENROU, HYGOV, SEXS. Statistical analysis are performed individually for each fuel type.

Simulation results for a loss of 445-MW generation and a three-phase fault at bus 225 are displayed in Fig.16.

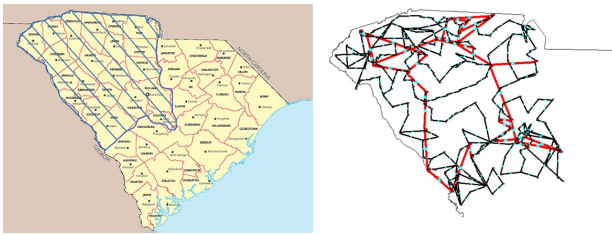

Fig. 15. Geographic footprint and one-line diagram of the 500-bus case

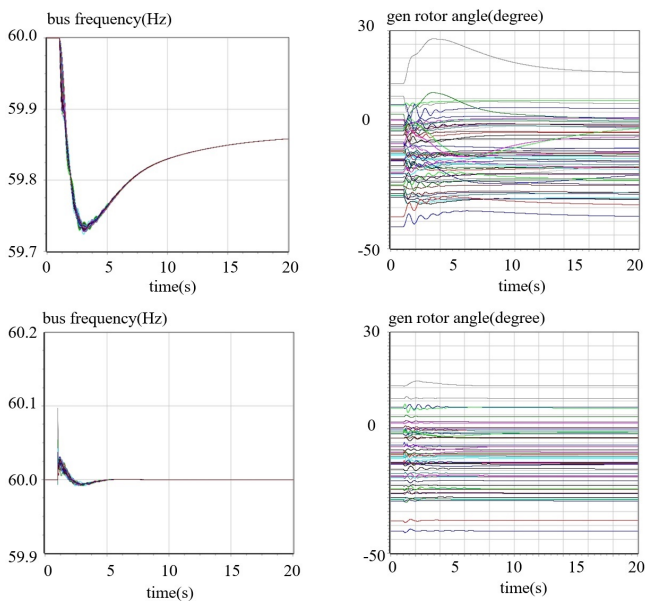

Fig. 16. Selected simulation results (upper: loss of a 445-MW generation at 1s; lower: a three-phase fault on bus 225 at 1s (cleared in 0.01s))

V. CONCLUSION

In this paper, we base on publicly available data and statistics summarized from the actual system model to produce a synthetic network dynamic model. Detailed statistical analysis performed on selected machine / governor / exciter / stabilizer models is presented to illustrate the statistical extension process to include generator dynamic models. Model validation and tuning process for excitation control systems is introduced to verify and properly modify the obtained model parameters. The synthetic dynamic models can be used for power system planning, generator siting and some other applications related to power system transient stability.

The proposed method is general enough to consider multiple fuel types and various models for each fuel type. Although this paper uses two specific footprints to illustrate the synthetic network creation process, the proposed methodology is general enough for applications to other footprints of interest. The developed synthetic networks with dynamic models can enable research using large-scale cases available publicly.

REFERENCES

- [1] P. Kundur, *Power System Stability and Control*. New York, NY: McGraw-Hill, 1994.
- [2] P. Sauer and M. Pai, *Power System Dynamics and Stability*. Champaign, IL: Stripes Publishing L.L.C., 1997.
- [3] Power System Dynamic Performance, "Benchmark systems for small-signal stability analysis and control," August 2015. [Online]. Available: <http://resourcecenter.ieee-pes.org/pes/product/technical-publications/PESTR18>.
- [4] University of Washington, "Power systems test case archive." [Online]. Available: <http://www2.ee.washington.edu/research/pstca>
- [5] Illinois Center for a Smarter Electric Grid, University of Illinois, "Power cases." [Online]. Available: <http://icseg.iti.illinois.edu/power-cases/>
- [6] A. Semerow, S. Hhn, M. Luther, W. Sattinger, H. Abildgaard, A. D. Garcia, and G. Giannuzzi, "Dynamic study model for the interconnected power system of continental europe in different simulation tools," in *PowerTech, 2015 IEEE Eindhoven*, June 2015, pp. 1–6.
- [7] P. Mackin, R. Daschmans, B. Williams, B. Haney, R. Hunt, and J. Ellis, "Dynamic simulation studies of the frequency response of the three U.S. interconnections with increased wind generation report," December 2010. [Online]. Available: http://www.nerc.com/FilingsOrders/us/FERCOrdersRules/Dynamic_Simulation_Studies.pdf.
- [8] T. Xu and T. Overbye, "Real-time event detection and feature extraction using pmu measurement data," in *2015 IEEE International Conference on Smart Grid Communications (SmartGridComm)*, Nov 2015, pp. 265–270.
- [9] A. B. Birchfield, K. M. Gegner, T. Xu, K. S. Shetye, and T. J. Overbye, "Statistical considerations in the creation of realistic synthetic power grids for geomagnetic disturbance studies," *IEEE Transactions on Power Systems*, vol. 32, no. 2, pp. 1502–1510, March 2017.
- [10] A. B. Birchfield, T. Xu, K. M. Gegner, K. S. Shetye, and T. J. Overbye, "Grid structural characteristics as validation criteria for synthetic networks," *IEEE Transactions on Power Systems*, vol. PP, no. 99, pp. 1–1, 2016.
- [11] "Electric Grid Test Case Repository - Synthetic Electric Grid Cases." [Online]. Available: <https://electricgrids.engr.tamu.edu/>
- [12] T. Xu, A. B. Birchfield, K. M. Gegner, K. S. Shetye, and T. J. Overbye, "Application of large-scale synthetic power system models for energy economic studies," *accepted by Hawaii International Conference on System Sciences (HICSS-50)*.
- [13] "Dynamic models for turbine-governors in power system studies." [Online]. Available: http://sites.ieee.org/fw-pes/files/2013/01/PES_TR1.pdf
- [14] "Developing generic dynamic models for the 2030 eastern interconnection grid." [Online]. Available: <http://info.ornl.gov/sites/publications/files/Pub47049.pdf>.
- [15] Power Transmission System Planning Software, "Program application guide, volume 2."

- [16] Australian Energy Market Operator, "Turbine governor testing and model validation guideline," May 2015. [Online]. Available: <https://www.aemo.com.au/-/media/Files/PDF/Turbine-Governor-Testing-and-Model-Validation-Guideline.pdf>
- [17] "IEEE guide for identification, testing, and evaluation of the dynamic performance of excitation control systems," *IEEE Std 421.2-2014 (Revision of IEEE Std 421.2-1990)*, pp. 1–63, June 2014.
- [18] "IEEE recommended practice for excitation system models for power system stability studies," *IEEE Std 421.5-2016 (Revision of IEEE Std 421.5-2005)*, pp. 1–207, Aug 2016.

Ti Xu (S'12) received the B.S. degree in 2011 from Tsinghua University, Beijing, P.R.C., and the M.S. degree in 2014 from the University of Illinois at Urbana-Champaign, Urbana, IL, USA. He is currently a Ph.D. candidate in Electrical and Computer Engineering at the University of Illinois at Urbana-Champaign, Urbana, IL, USA.

Adam B. Birchfield (S'13) received the B.E.E. degree in 2014 from Auburn University, Auburn, AL, USA, and the M.S. degree in 2016 from the University of Illinois at Urbana-Champaign, Urbana, IL, USA. He is now pursuing the Ph.D. degree in Electrical and Computer Engineering at the Texas A&M University, College Station, TX, USA.

Komal S. Shetye (S'10–M'11) received the B. Tech. degree from the University of Mumbai, Mumbai, India, in 2009, and the M.S. degree in electrical engineering from the University of Illinois at Urbana-Champaign, Urbana, IL, USA, in 2011. She is currently a Senior Research Engineer with the Information Trust Institute, University of Illinois at Urbana-Champaign, Urbana, IL, USA.

Thomas J. Overbye (S'87–M'92–SM'96–F'05) received the B.S., M.S., and Ph.D. degrees in electrical engineering from the University of Wisconsin-Madison, Madison, WI, USA. He is currently the Professor of Electrical and Computer Engineering at the Texas A&M University, College Station, TX, USA.